

DATA SHEET

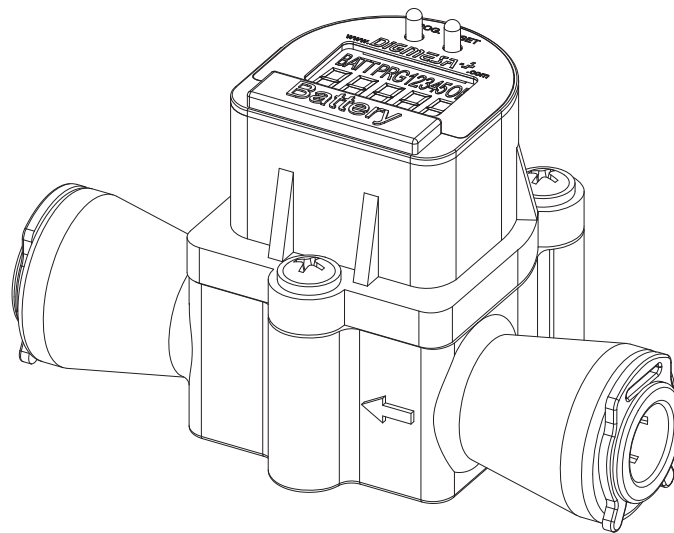

DIGIMESA[®]
CHOOSE THE ORIGINAL

FHKU LCD John Guest 3/8" Arnite
Part number: 938-75XX/F21

Digimesa AG, Keltenstrasse 31, CH-2563 Ipsach / Switzerland
Phone +41 (32) 332 77 77, Fax +41 (32) 332 77 88

www.digimesa.com

Version 04 FHKU J6 3/8" LCD 938-75XX/F21 GB Page 1-11

General Description

The Flow Sensor FHKU JG LCD is an universally applicable control device and Flow Sensor. It's working range can be individually defined according to its nozzle size. It guarantees most precise fluid measurements. Excellent suitably to the monitoring of ion exchanger filter cartridges and for the treatment of water.

Specific applications: Linear inlet and outlet. Time and date administration, upward or backwards counters, history with date, instantaneous value announcement, automatic impulse calibration, litres and /or alarm-date, securit code prevents tempering by unauthorised persons. Current supply over lithium battery. With a battery change all attitudes and values are stored. Hose diameters from 3/8" (9.5mm) can be directly connected.

Approvals / Standards

EMV-Standard:
EN 61326: 1997 + A1:1998 + A2: 2001
(IEC 61326: 2002)



Material:

Housing: PBT 35%GF (Arnite)
Bearing pin: Inox 1.4305 (18/8)
Nozzel: Ø 1.0, 1.2, 2.0, 2.5mm
PPS 40%GF (Ryton)
Nozzel: Ø 3.0, 4.0mm Inox 1.4305
Nozzel: 5.6mm like housing
O-ring: MVQ (Silikon)
Turbine: PVDF
Magnets: Keramik Sr Fe O
(in contact with the medium)
Screw: PT-screws
(Phillips cross recessed)

Technical data:

Flow rate: 0.041 - 15 l/min depending on the nozzle diameter
Continuous operation: < 500 rpm
Measuring accuracy: +/- 2.0%
Repetition: < +/- 0.25%
Temperature range: +1°C to +60°C
33.8°F to 140°F
Pressure range: 10 bar at 20°C
145 psi /68°F
Mounting position: Horizontal *
Nozzle size: Ø 1.0, 1.2, 2.0, 2.5, 3.0, 4.0, 5.6 mm

Technical data upper section:

Splash-proof: IP X4
Limit-measurement: 1 - 99999 Litres
Pulses/litre: 1 - 65000
Statistics memory: the last 5 zero resets
Display: 5 digit
Counter: upward 0 to 99999 litres with and without limit downward 99999 to -9999 litres
Instantaneous value: l/min
Battery: lithium CR 2032

Dimensions in mm:

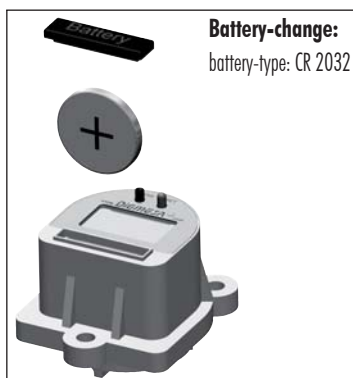
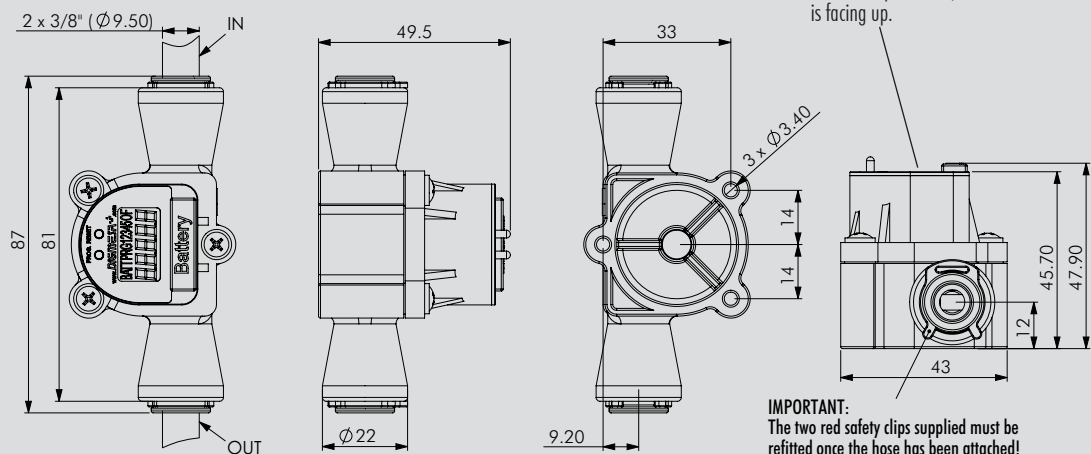

We reserve the right to make modifications in the interests of technical progress.

RESISTANCE

Special regulations which must be complied with by the flowmeter manufacturer apply to each country, e.g. CE, NSF, FDA and SK. The various media flowing through the flowmeter differ from application to application. You are advised to enquire with the medium manufacturer as to whether the entire installation and the flowmeter are resistant to the medium itself (see Material)!

Technical data John Guest

Technical Specification

Working Temperatures and Pressures

John Guest Cartridges and Half Cartridges are suitable for the following pressures and temperatures.

Acetal Cartridges

Those Plastic Cartridges which have the prefix PI, PM, CI, CM, PCI PCM or ECI.

Temperature	Pressure	
	5/32" - 5/16" 4mm - 8mm	3/8" - 5/8" 10mm - 22mm
Air*		
-20°C	16 Bar	10 Bar
Potable Liquids and Air*		
+1°C	16 Bar	10 Bar
+23°C	16 Bar	10 Bar
+65°C	10 Bar	7 Bar

*Only cartridges with a Nitrile rubber 'O' ring should be used for air, these can be identified by part numbers with prefix PI or PM.

Polypropylene Cartridges

Those Plastic Cartridges which have the prefix PP.

Temperature	Pressure	
	1/4" - 3/8"	
Potable Liquids		
+1°C	10 Bar	(150psi at 35°F)
+20°C	10 Bar	(150psi at 70°F)
+60°C	4 Bar	(60psi at 140°F)

Metal Cartridges

Those Metal Cartridges which have the prefix MM, MI, CM, CI, or LM.

Temperature	Pressure	
	5/32" - 5/16" 4mm - 8mm	3/8" - 5/8" 10mm - 22mm
Air*		
-20°C	16 Bar	10 Bar
+23°C	16 Bar	10 Bar
+70°C	10 Bar	7 Bar

* The above ratings are for air. For use with other fluids or at other temperatures and pressures, please consult our Customer Services Department.

The maximum operating temperatures and pressures are dependent on the housing material, wall thickness, vibration and pulsation, tube type and general operating conditions.

Customers are advised to carry out appropriate testing to ensure cartridges are suitable for their application.

Housing Materials

Plastic Half Cartridges are only recommended for use with plastic and soft metal housing materials. Avoid any form of housing finish, such as chromium plating or anodising, which significantly increases surface hardness

Tube Types

Plastic Tube - Polyethylene, nylon and polyurethane conforming to the tolerances shown below. For soft or thin walled tube we recommend the use of tube inserts.

Metal Tube (soft) - Brass, copper or mild steel conforming to the tolerances shown below.

Metal Tube (hard) - We do not recommend our cartridges for hard metal tubes.

It is essential that the outside diameter is free from score marks and that the tube be deburred before inserting into the cartridge.

Tube Tolerances

Cartridges are offered for tubes with outside diameters to the following tolerances.

Size (inches)	5/32 - 3/16	1/4 - 5/8
Tolerance (inches)	+0.001/-0.003	+0.001/-0.004
Size (mm)	4mm - 5mm	6mm - 22mm
Tolerance (mm)	+0.05/-0.07	+0.05/-0.10

Installation and System Testing

Products should be kept clean and undamaged before use.

All installations must be pressure tested after installation to ensure system integrity before handing over to the final user. See also "Making a connection".

Cleaners and Sanitising of Acetal Fittings

The external surfaces of John Guest products must not come into contact with oxidising or acidic cleaners and sanitising agents, for example (but not limited to) those below pH 4, high in sodium hypochlorite level (bleach) or containing hydrogen peroxide. Our plastic material suppliers recommend ECOLAB Oasis 133 as a suitable cleaner for the external surfaces of acetal products manufactured by John Guest.

Several different methods exist for sanitising the internal surfaces of fluid systems, including sodium hypochlorite, hydrogen peroxide, chlorine dioxide or ozone. It is entirely the responsibility of the end user to determine if the chosen method is suitable for use with John Guest products over the planned working life of the system. However, to avoid unnecessary early failure, John Guest requires that the disinfection solution must be immediately flushed out at all draw off points with fresh, wholesome water at the end of the disinfection period. **The solution must not be left in the system.** Disinfection solutions must only come into contact with the internal (fluid carrying) surfaces of the system. If any other surfaces of a fitting come into contact with disinfection solution **the whole fitting must be replaced immediately.** Details of which products are made from Acetal are shown in our catalogues but generally John Guest products incorporating Acetal are designated by the part number prefix PI, PM, CI, CM and RM. Polypropylene fittings offer greater resistance to aggressive chemicals than Acetal fittings. Polypropylene does not have the same mechanical properties as Acetal and John Guest polypropylene fittings are generally designated by the part number prefix PP or PPM.

Product Design

John Guest has a policy of continuous research and development and reserves the right to amend without notice the specification and design of all products. Product descriptions and sizes are approximate and John Guest reserves the right to supply products which may have minor and negligible deviations from that printed in catalogues etc. (or from products previously supplied).

Warranty

Whilst we give a warranty against defects in manufacture or materials, it is the responsibility of the specifier to ensure that fittings and related products are suitable for their application. The installation must be carried out correctly in accordance with our recommendations, complying with recognised codes of practice and relevant national standards, and be properly maintained. Please refer to our terms and conditions of sale.

Product Selection

Due to the wide variety of operating conditions, applications and uses of our products, it is the user's / specifiers responsibility, through their own testing analysis, to ensure correct product selection for their applications.

Installers of John Guest Cartridges are fully responsible for the final product assembly, testing, quality and application.

Side Loads

Connections should not be subject to excessive side loads or used as support brackets. Tubing and fittings should be adequately supported to prevent excessive side loading.

www.johnguest.com

10

John Guest GmbH

Ludwig-Erhard-Allee 30, D-33719 Bielefeld

Phone: (49)-521 / 9 72 56-0

Fax: (49)-521 / 9 72 56-80

Internet: <http://www.johnguest.com>

<http://www.speedfit.co.uk>

We reserve the right to make modifications in the interests of technical progress.

Version 04 FHKU JG 3/8" LCD 938-75XV/F21 GB Page 3-11

FHK-LCD query and display function

<p>Upcounter (1 on the display) Displays the flow quantity in litres.</p> <p>Measuring range without limit function: 0 to 99999 litres with max. 3 places after the decimal point (dependent on the number of pulses).</p> <p>With limit function: 0 to 99999 litres (no place after the decimal point).</p> <p>„OF“ (OverFlow) is displayed if 99999 is exceeded.</p> <p>Alarm functions: Display blinks when the limit value or the alarm date is reached.</p> <p>Downcounter (2 on the display) Displays the remaining quantity in litres through to alarm.</p>	<p>Measuring range without limit function: Downcounter is deactivated. „OFF“ is shown on the display.</p> <p>With limit function: 99999 to -9999 litres (no place after the decimal point).</p> <p>„OF“ (OverFlow) is displayed if -9999 is undershot.</p> <p>Alarm functions: Display blinks when value 0 litres or alarm date is reached.</p> <p>Instantaneous value (3 on the display) Displays the current flow rate in l/min.</p> <p>Measuring range: 0 to 999.99 l/min with 2 places after the decimal point.</p> <p>Time / date (4 on the display) Displays the time and the date.</p>	<p>Alarm-date (5 on the display) Without time limit function: The alarm date is deactivated. „OFF“ is shown on the display.</p> <p>With time limit function: The alarm date is displayed.</p> <p>History 1-5 The 5 last history values are displayed. They are displayed consecutively with the memory level (1-5). The data of the last reset is saved at memory level 1.</p> <p>The following values are displayed as a „ticker“ text:</p> <ul style="list-style-type: none"> • HL (History Liter) flow quantity • Hd (History date) reset-date
--	---	---

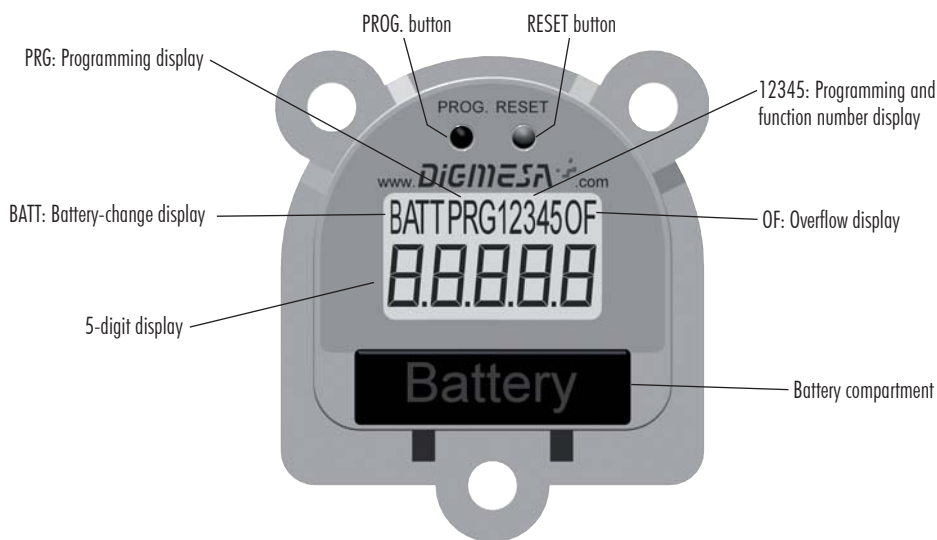

FHK-LCD programming function

<p>PRG Setting the security code 4-digit security code.</p> <p>The security function is deactivated if the value of the security code is 0000.</p> <p>PRG1 Setting time/date 24 h time format (hh-mm)/date (DD.MM.YY).</p> <p>The current date is saved under Hd (history date) each time the unit is reset.</p>	<p>PRG2 Setting the limit value Limit value in litres (0 to 99999)</p> <p>The limit value corresponds to the number of litres before an alarm is triggered and is the initial value when downcounting.</p> <p>The limit function and downcounter are deactivated if the limit value is 0.</p> <p>PRG3 Setting the time limit value Time limit value in months (0 to 99)</p> <p>The time limit value corresponds to the number of months before an alarm is triggered.</p> <p>The time limit function is deactivated if the time limit value is 0.</p>	<p>PRG4 Setting the calibration value (manual) Calibration value in pulses per litre (1 to 65000)</p> <p>PRG5 Setting the calibration value (automatic) This function automatically calculates and sets the calibration value of the entire installation and the medium to be measured.</p> <p>The weight of the flow medium is entered in gram.</p>
--	---	--



Measurement Curve FHKU 1.00 mm (#938-7510/F21)

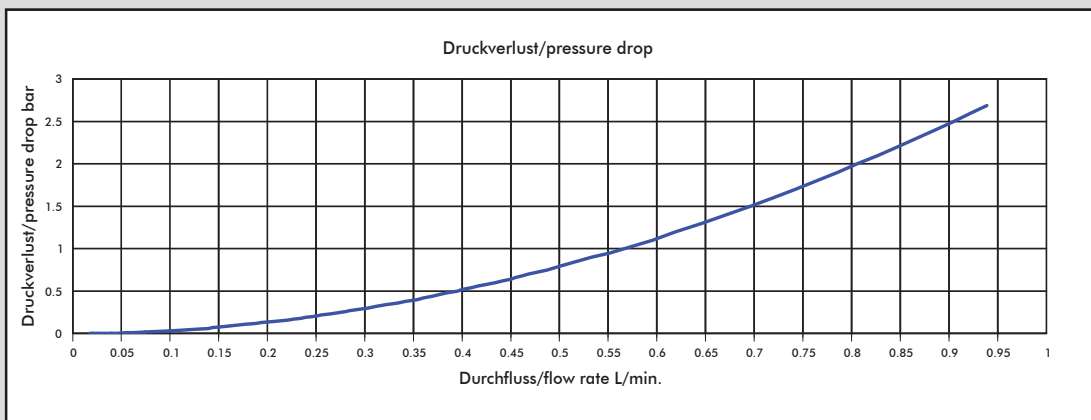
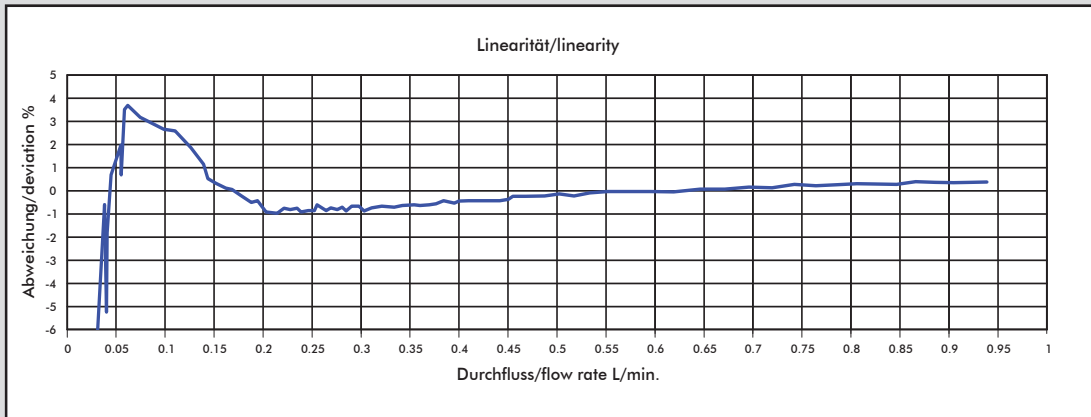

Medium: Water / max. Pressure: 3.3 bar

Nozzle size	Pulses/litre	g/pulse	min. flow rate in [litres/min] at linear start	max. flow rate in [litres/min]	Pressure loss in [bar]
Ø 1.00 mm	4126	0.24	0.041	0.56	1.0
Ø 1.20 mm	3400	0.29	0.050	0.82	1.0
Ø 2.00 mm	1976	0.50	0.091	2.40	1.0
Ø 2.50 mm	1520	0.65	0.150	3.74	1.0
Ø 3.00 mm	1130	0.88	0.102	5.63	1.0
Ø 4.00 mm	762	1.31	0.123	8.38	0.80
Ø 5.60 mm	472	2.11	0.308	9.26	0.45

MEASUREMENT TIPS

- Ensure that there is no fast-pulsatory movement of the media
- Ensure that there are no reverse pressure surges
- Ensure that there is no air in the system
- Keep the pressure loss as small as possible
- Note the mounting position of the flowmeter
- Min/max flow should be in the linear range of the selected flowmeter
- Clean the system at appropriate intervals
- Avoid humidity at the battery and at the electrical contacts
- Avoid stray pick-up via the cable (Do not lay cables in parallel with high current loads)

The values specified must be considered as approximate values.

The number of pulses per litre may differ depending on medium and installation.

We recommend to calibrate the number of pulses per litre in line with the complete installation.

Measurement Curve FHKU 1.20 mm (#938-7512/F21)

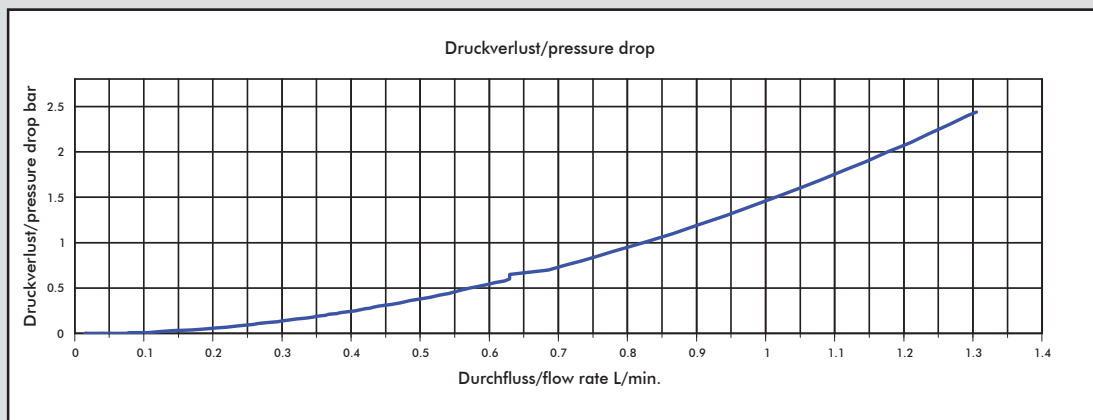
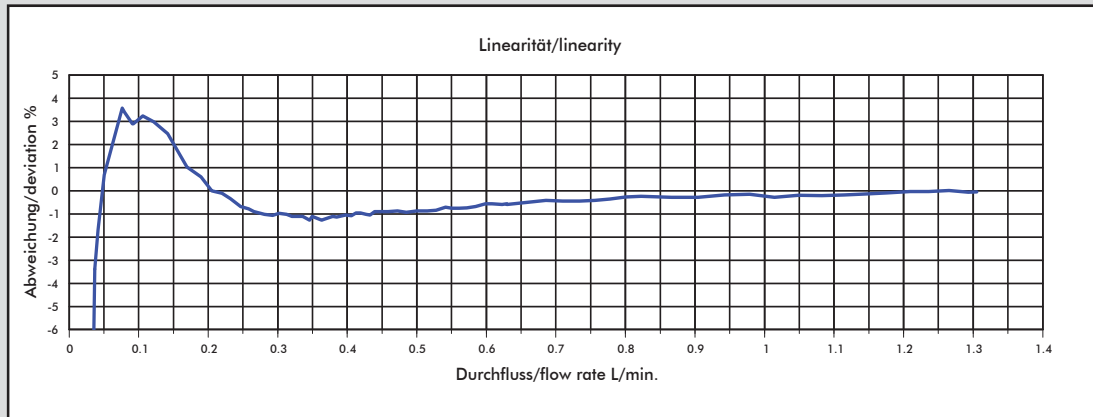

Medium: Water / max. Pressure: 3.3 bar

Nozzle size	Pulses/litre	g/pulse	min. flow rate in [litres/min] at linear start	max. flow rate in [litres/min]	Pressure loss in [bar]
Ø 1.00 mm	4126	0.24	0.041	0.56	1.0
Ø 1.20 mm	3400	0.29	0.050	0.82	1.0
Ø 2.00 mm	1976	0.50	0.091	2.40	1.0
Ø 2.50 mm	1520	0.65	0.150	3.74	1.0
Ø 3.00 mm	1130	0.88	0.102	5.63	1.0
Ø 4.00 mm	762	1.31	0.123	8.38	0.80
Ø 5.60 mm	472	2.11	0.308	9.26	0.45

MEASUREMENT TIPS

- Ensure that there is no fast-pulsatory movement of the media
- Ensure that there are no reverse pressure surges
- Ensure that there is no air in the system
- Keep the pressure loss as small as possible
- Note the mounting position of the flowmeter
- Min/max flow should be in the linear range of the selected flowmeter
- Clean the system at appropriate intervals
- Avoid humidity at the battery and at the electrical contacts
- Avoid stray pick-up via the cable (Do not lay cables in parallel with high current loads)

The values specified must be considered as approximate values.

The number of pulses per litre may differ depending on medium and installation.

We recommend to calibrate the number of pulses per litre in line with the complete installation.

Measurement Curve FHKU 2.00 mm (#938-7520/F21)

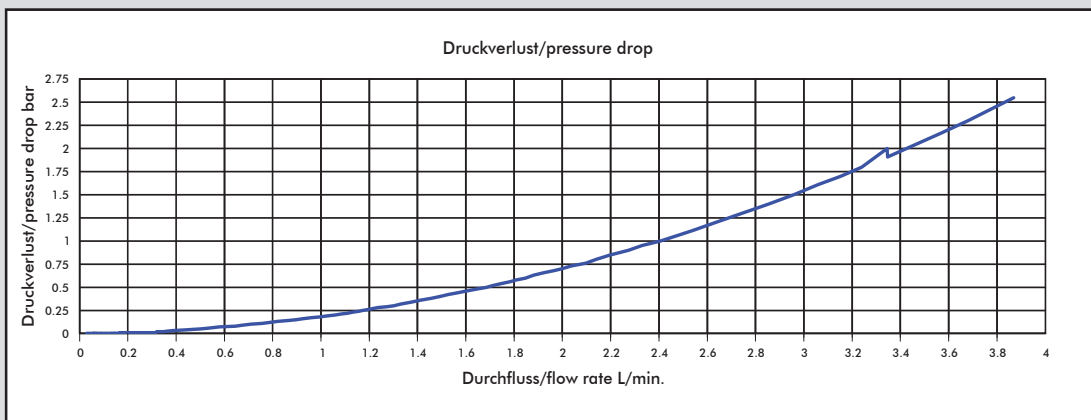
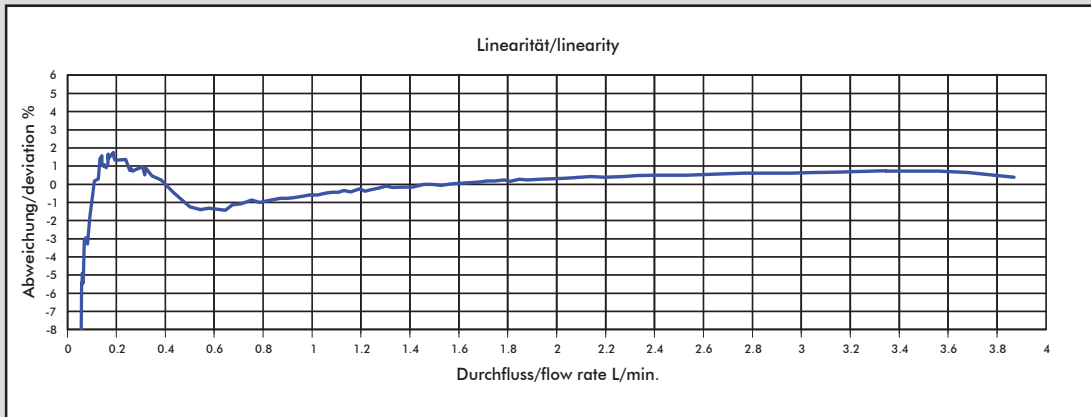

Medium: Water / max. Pressure: 3.3 bar

Nozzle size	Pulses/litre	g/pulse	min. flow rate in [litres/min] at linear start	max. flow rate in [litres/min]	Pressure loss in [bar]
Ø 1.00 mm	4126	0.24	0.041	0.56	1.0
Ø 1.20 mm	3400	0.29	0.050	0.82	1.0
Ø 2.00 mm	1976	0.50	0.091	2.40	1.0
Ø 2.50 mm	1520	0.65	0.150	3.74	1.0
Ø 3.00 mm	1130	0.88	0.102	5.63	1.0
Ø 4.00 mm	762	1.31	0.123	8.38	0.80
Ø 5.60 mm	472	2.11	0.308	9.26	0.45

MEASUREMENT TIPS

- Ensure that there is no fast-pulsatory movement of the media
- Ensure that there are no reverse pressure surges
- Ensure that there is no air in the system
- Keep the pressure loss as small as possible
- Note the mounting position of the flowmeter
- Min/max flow should be in the linear range of the selected flowmeter
- Clean the system at appropriate intervals
- Avoid humidity at the battery and at the electrical contacts
- Avoid stray pick-up via the cable (Do not lay cables in parallel with high current loads)

The values specified must be considered as approximate values.

The number of pulses per litre may differ depending on medium and installation.

We recommend to calibrate the number of pulses per litre in line with the complete installation.

Measurement Curve FHKU 2.50 mm (#938-7525/F21)

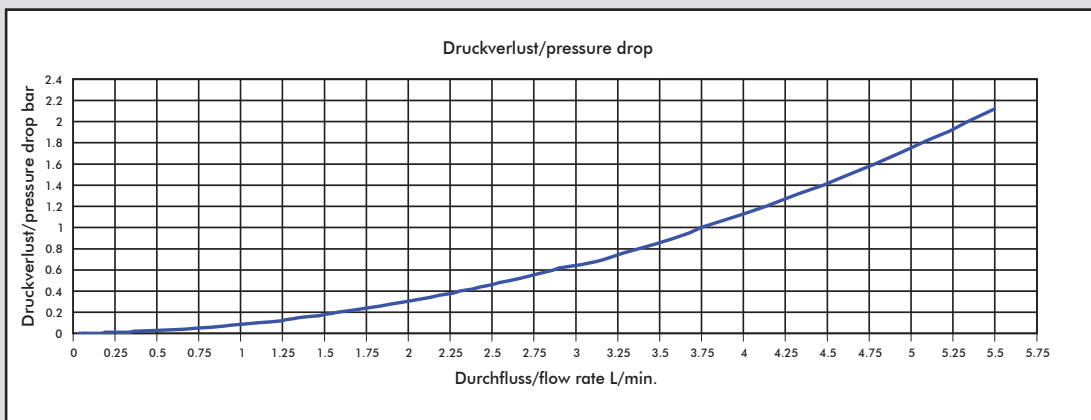
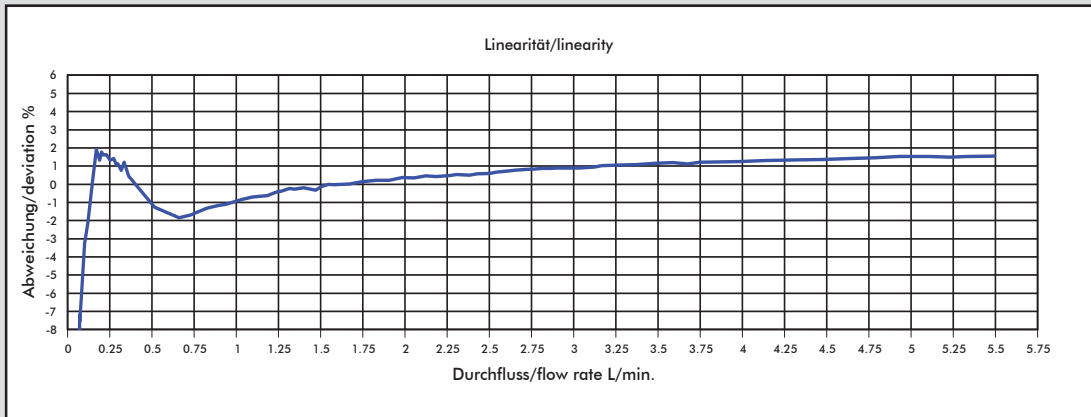

Medium: Water / max. Pressure: 3.3 bar

Nozzle size	Pulses/litre	g/pulse	min. flow rate in [litres/min] at linear start	max. flow rate in [litres/min]	Pressure loss in [bar]
Ø 1.00 mm	4126	0.24	0.041	0.56	1.0
Ø 1.20 mm	3400	0.29	0.050	0.82	1.0
Ø 2.00 mm	1976	0.50	0.091	2.40	1.0
Ø 2.50 mm	1520	0.65	0.150	3.74	1.0
Ø 3.00 mm	1130	0.88	0.102	5.63	1.0
Ø 4.00 mm	762	1.31	0.123	8.38	0.80
Ø 5.60 mm	472	2.11	0.308	9.26	0.45

MEASUREMENT TIPS

- Ensure that there is no fast-pulsatory movement of the media
- Ensure that there are no reverse pressure surges
- Ensure that there is no air in the system
- Keep the pressure loss as small as possible
- Note the mounting position of the flowmeter
- Min/max flow should be in the linear range of the selected flowmeter
- Clean the system at appropriate intervals
- Avoid humidity at the battery and at the electrical contacts
- Avoid stray pick-up via the cable (Do not lay cables in parallel with high current loads)

The values specified must be considered as approximate values.

The number of pulses per litre may differ depending on medium and installation.

We recommend to calibrate the number of pulses per litre in line with the complete installation.

Measurement Curve FHKU 3.00 mm (#938-7530/21)

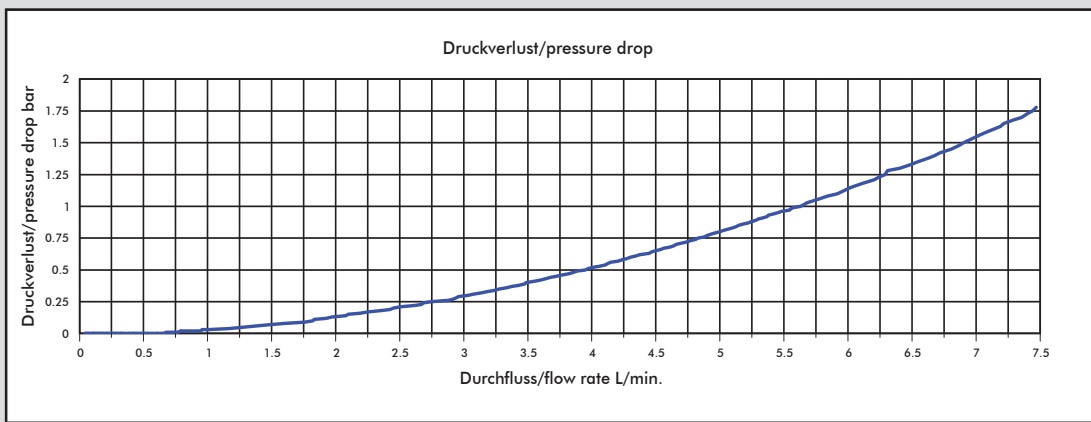
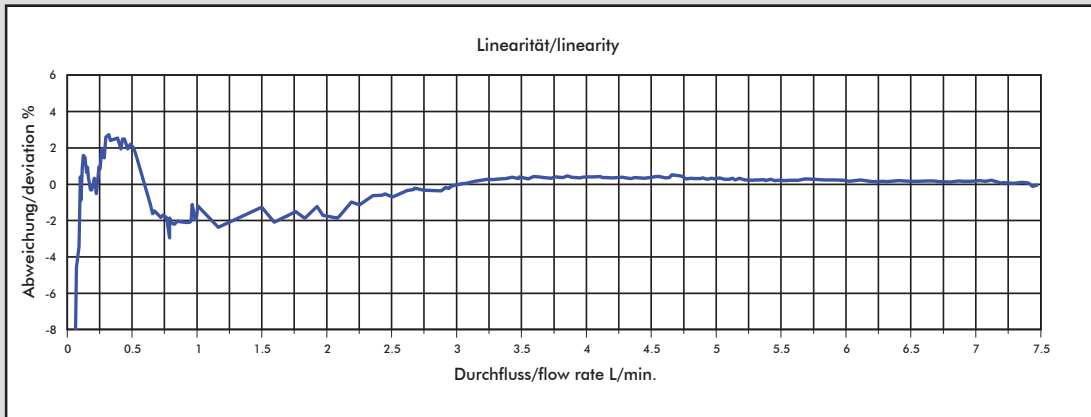

Medium: Water / max. Pressure: 3.3 bar

Nozzle size	Pulses/litre	g/pulse	min. flow rate in [litres/min] at linear start	max. flow rate in [litres/min]	Pressure loss in [bar]
Ø 1.00 mm	4126	0.24	0.041	0.56	1.0
Ø 1.20 mm	3400	0.29	0.050	0.82	1.0
Ø 2.00 mm	1976	0.50	0.091	2.40	1.0
Ø 2.50 mm	1520	0.65	0.150	3.74	1.0
Ø 3.00 mm	1130	0.88	0.102	5.63	1.0
Ø 4.00 mm	762	1.31	0.123	8.38	0.80
Ø 5.60 mm	472	2.11	0.308	9.26	0.45

The values specified must be considered as approximate values.

The number of pulses per litre may differ depending on medium and installation.

We recommend to calibrate the number of pulses per litre in line with the complete installation.

MEASUREMENT TIPS

- Ensure that there is no fast-pulsatory movement of the media
- Ensure that there are no reverse pressure surges
- Ensure that there is no air in the system
- Keep the pressure loss as small as possible
- Note the mounting position of the flowmeter
- Min/max flow should be in the linear range of the selected flowmeter
- Clean the system at appropriate intervals
- Avoid humidity at the battery and at the electrical contacts
- Avoid stray pick-up via the cable (Do not lay cables in parallel with high current loads)

Measurement Curve FHKU 4.00 mm (#938-7540/21)

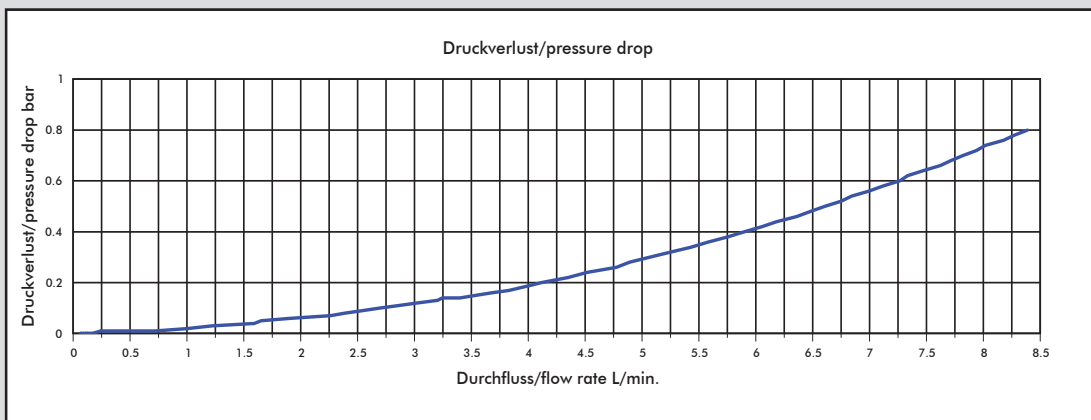
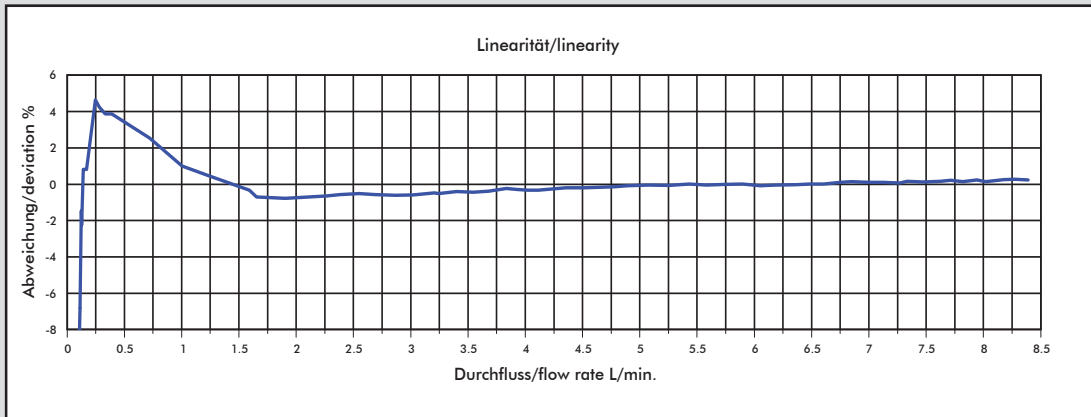

Medium: Water / max. Pressure: 3.3 bar

Nozzle size	Pulses/litre	g/pulse	min. flow rate in [litres/min] at linear start	max. flow rate in [litres/min]	Pressure loss in [bar]
Ø 1.00 mm	4126	0.24	0.041	0.56	1.0
Ø 1.20 mm	3400	0.29	0.050	0.82	1.0
Ø 2.00 mm	1976	0.50	0.091	2.40	1.0
Ø 2.50 mm	1520	0.65	0.150	3.74	1.0
Ø 3.00 mm	1130	0.88	0.102	5.63	1.0
Ø 4.00 mm	762	1.31	0.123	8.38	0.80
Ø 5.60 mm	472	2.11	0.308	9.26	0.45

MEASUREMENT TIPS

- Ensure that there is no fast-pulsatory movement of the media
- Ensure that there are no reverse pressure surges
- Ensure that there is no air in the system
- Keep the pressure loss as small as possible
- Note the mounting position of the flowmeter
- Min/max flow should be in the linear range of the selected flowmeter
- Clean the system at appropriate intervals
- Avoid humidity at the battery and at the electrical contacts
- Avoid stray pick-up via the cable (Do not lay cables in parallel with high current loads)

The values specified must be considered as approximate values.

The number of pulses per litre may differ depending on medium and installation.

We recommend to calibrate the number of pulses per litre in line with the complete installation.

Measurement Curve FHKU 5.60 mm (#938-7556/21)

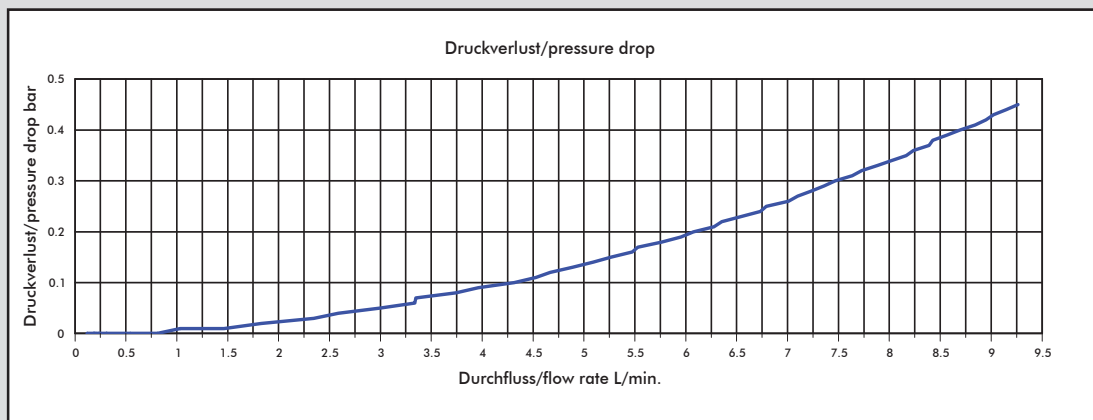
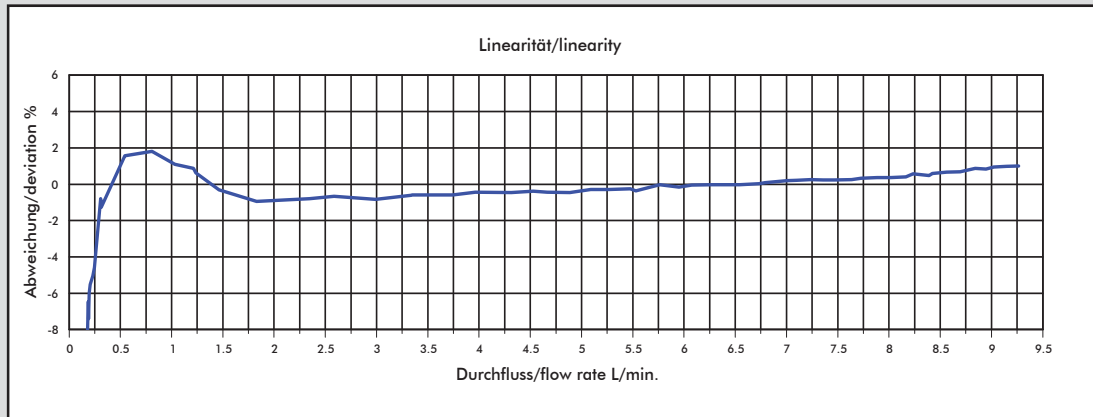

Medium: Water / max. Pressure: 3.3 bar

Nozzle size	Pulses/litre	g/pulse	min. flow rate in [litres/min] at linear start	max. flow rate in [litres/min]	Pressure loss in [bar]
Ø 1.00 mm	4126	0.24	0.041	0.56	1.0
Ø 1.20 mm	3400	0.29	0.050	0.82	1.0
Ø 2.00 mm	1976	0.50	0.091	2.40	1.0
Ø 2.50 mm	1520	0.65	0.150	3.74	1.0
Ø 3.00 mm	1130	0.88	0.102	5.63	1.0
Ø 4.00 mm	762	1.31	0.123	8.38	0.80
Ø 5.60 mm	472	2.11	0.308	9.26	0.45

MEASUREMENT TIPS

- Ensure that there is no fast-pulsatory movement of the media
- Ensure that there are no reverse pressure surges
- Ensure that there is no air in the system
- Keep the pressure loss as small as possible
- Note the mounting position of the flowmeter
- Min/max flow should be in the linear range of the selected flowmeter
- Clean the system at appropriate intervals
- Avoid humidity at the battery and at the electrical contacts
- Avoid stray pick-up via the cable (Do not lay cables in parallel with high current loads)

The values specified must be considered as approximate values.

The number of pulses per litre may differ depending on medium and installation.

We recommend to calibrate the number of pulses per litre in line with the complete installation.